



TQ-HPR50 System



Service Manual

Technology
in Quality





Contents

Important notice	4
Hazard Classification.....	4
Ensuring safety	4
Connecting the e-bike (TQ drive system) with the PC	6
Mountain bike e-systems overview	7
Road e-systems overview	8
Overview of the tools used in the manual	9
Installation of the display (V01 and V02)	10
Assembly of the REMOTE V02	12
Installation of Drive Unit HPR50	14
Installation of the Battery HPRV01	18
Installing the wiring harness.....	20
Installation of the speed sensor.....	22
Installation of the Smart Box	24
Installation of the Y-splitter (AUX and AXS)	26
Manual Dealer Service Tool (DST)	28
Troubleshooting.....	30

Important notice

- ▶ The service manual is geared towards professional and training bicycle mechanics.
- ▶ Be sure to also read the included operating instructions of the various products.
- ▶ Do not make any modifications to the products that are not described in the manual or that go beyond the contained information.
- ▶ You will find all service manuals and user manuals, along with the current versions, in the TQ dealer portal: www.tq-group.com/en/e-bike-portal/
- ▶ Please also observe the rules of the country, state or region in which you operating.

For safety reasons, read this service manuals thoroughly and follow the instructions for proper use.

Hazard Classification

DANGER

This signal word designates a hazard with a **high** degree of risk, which, if not averted, will result in death or severe injury.

WARNING

This signal word designates a hazard with a **moderate** degree of risk, which, if not averted, will result in death or severe injury.

CAUTION

This signal word designates a hazard with a **low** degree of risk, which, if not averted, could result in minor or moderate injury.

NOTICE

A notice, as set out by this manual, is important information about the product or the respective section of the manual requiring special attention.

Ensuring safety

DANGER

Be sure to follow these instructions when performing installation and service work:

- ▶ Make absolutely sure that the system is switched off or the Battery and Range Extender is unplugged before performing any work on the system or e-bike.
- ▶ Unintentional activation of the electric drive system can result in injury.
- ▶ Never ship a defective Battery or Range Extender. A defective Battery or Range Extender may neither be charged nor used.

⚠ DANGER

Also inform the users about the following:

Handling of the batteries and chargers

- ▶ Do not open the battery housing or charger housing under any circumstances, and never attempt to dismantle them.
- ▶ Do not undertake any attempts to repair a damaged battery housing under any circumstances.
- ▶ Never break or perforate the battery
- ▶ Protect the battery against fire, severe heat, along with prolonged direct exposure to sunlight.
- ▶ Never immerse the battery in water.
- ▶ In case of improper use, fluid may leak out of the battery. Avoid any contact with the fluid. In case you come into contact with the fluid, wash it off with water. Also seek the attention of a physician if your eyes come into contact with the fluid. Fluid leaking out of the battery may lead to irritation or burns.
- ▶ In order to prevent damage to the battery, never subject the battery to mechanical impact.
- ▶ Keep the battery away from metal objects, as a danger of short-circuiting exists. Do not allow nails, screws or other small, sharp and/or metallic objects come into contact with the battery (charging port / discharge socket).
- ▶ Only use the designated TQ charger for charging the battery.
- ▶ Protect the charger from moisture. Otherwise, there is the risk of electric shock.
- ▶ Only operate the charger in dry rooms.
- ▶ Keep the charger clean. Soiling could lead to an electric shock.
- ▶ Never operate the charger on an easily combustible surface (e.g. paper, textiles etc.) or in a combustible environment. There is a fire risk due to the warming of the charger during charging.

⚠ WARNING

Strictly follow the instructions in the manuals when installing HPR products.

It is recommended to use only original TQ parts.

Wear approved eye protection when performing maintenance procedures, such as replacing components, for example.

You will also find additional product information in the user manuals of the individual TQ components.

Also inform the users about the following:

- ▶ When cycling, do not become distracted from the information indicated on the display, instead focus exclusively on the traffic. Otherwise, there is the risk of accident.
- ▶ Make sure before starting out that all screws and wheels are securely fastened.
- ▶ The assistance by the drive system depends on the one hand on the selected assistance level and on the other hand on the force that the rider is exerting on the pedals. The greater the force exerted on the pedals, the higher the level of motor assistance. The drive assistance stops when you stop pedaling.
- ▶ Only use the original TQ charger to charge the battery and ranger extender.
- ▶ The drive unit may heat up during operation, depending on the load and other additional influencing factors, causing the surface of the drive unit, along with adjacent components (motor covers) to become hot. Do not come into contact with the drive unit with your hands or legs during or after a ride. Otherwise, there is the risk of burns.

CAUTION

Also inform the users about the following:

- ▶ Please observe the notices in the user manuals and in the operating instructions of the bike.
- ▶ Prior to each charging cycle, check to ensure that the charger, cables and plugs are not damaged.
- ▶ Do not operate the charger if cables or plugs are damaged. Otherwise, there is the risk of electric shock.
- ▶ The charger may be used by children 8 years and older and by persons with restricted physical, sensory or mental abilities or lacking experience and knowledge if they are supervised or have been instructed in the safe use of the equipment and the resulting dangers. Children are not allowed to play with the equipment. Cleaning and user maintenance are not allowed to be carried out by children without supervision.
- ▶ Do not make any modification to the system, as this may lead to malfunctions and will also void the warranty.
- ▶ Also observe the charging, operating and storage temperatures of the battery.

Charging temperature range: 0 °C to 40 °C / 32 °F to 104 °F

Operating temperature: -5 °C to 40 °C / 23 °F to 104 °F

Storage temperature: 0 °C to 40 °C / 32 °F to 104 °F

Recommended storage temperature: 10 °C to 20 °C / 50 °F to 68 °F

NOTICE

Also inform the users about the following:

- ▶ Place blind plugs on all unused connections.
- ▶ Never clean the e-bike with a high-pressure washer, as this can result in malfunctions, defects or corrosion of the components.
- ▶ Do not stand the bike upside down. This could possibly damage the remote or the shift levers.
- ▶ The transport of lithium batteries is subject to country-specific laws and regulations. Please become informed about the respective regional rules, and follow them during transport.
- ▶ Do not remove the battery from the e-bike during the charging cycle.
- ▶ Never cycle with the e-bike when the charger is connected.
- ▶ Close the charge port cover if the charging cycle is completed or no service dongle is connected.
- ▶ Only use the designated TQ charger for charging the batteries.
- ▶ Use only an original HPR battery to supply the drive system with power.
- ▶ Clean the battery only with a soft, damp cloth.

Connecting the e-bike (TQ drive system) with the PC

The TQ service dongle V01 is intended for connecting the USB port of the PC with the HPR50 drive system and is not allowed to be used for other purposes or other manufacturers. The service dongle is required for the use of the TQ Dealer Service Tool and enables communication between the PC and the e-bike. With the help of this interface, the software of the Dealer Service Tool can access all the components of the e-bike drive system.

The Dealer Service Tool enables the following:

- ▶ System diagnostics of connected components
- ▶ Firmware Updates
- ▶ Service Reports
- ▶ E-bike Settings

Road e-systems overview

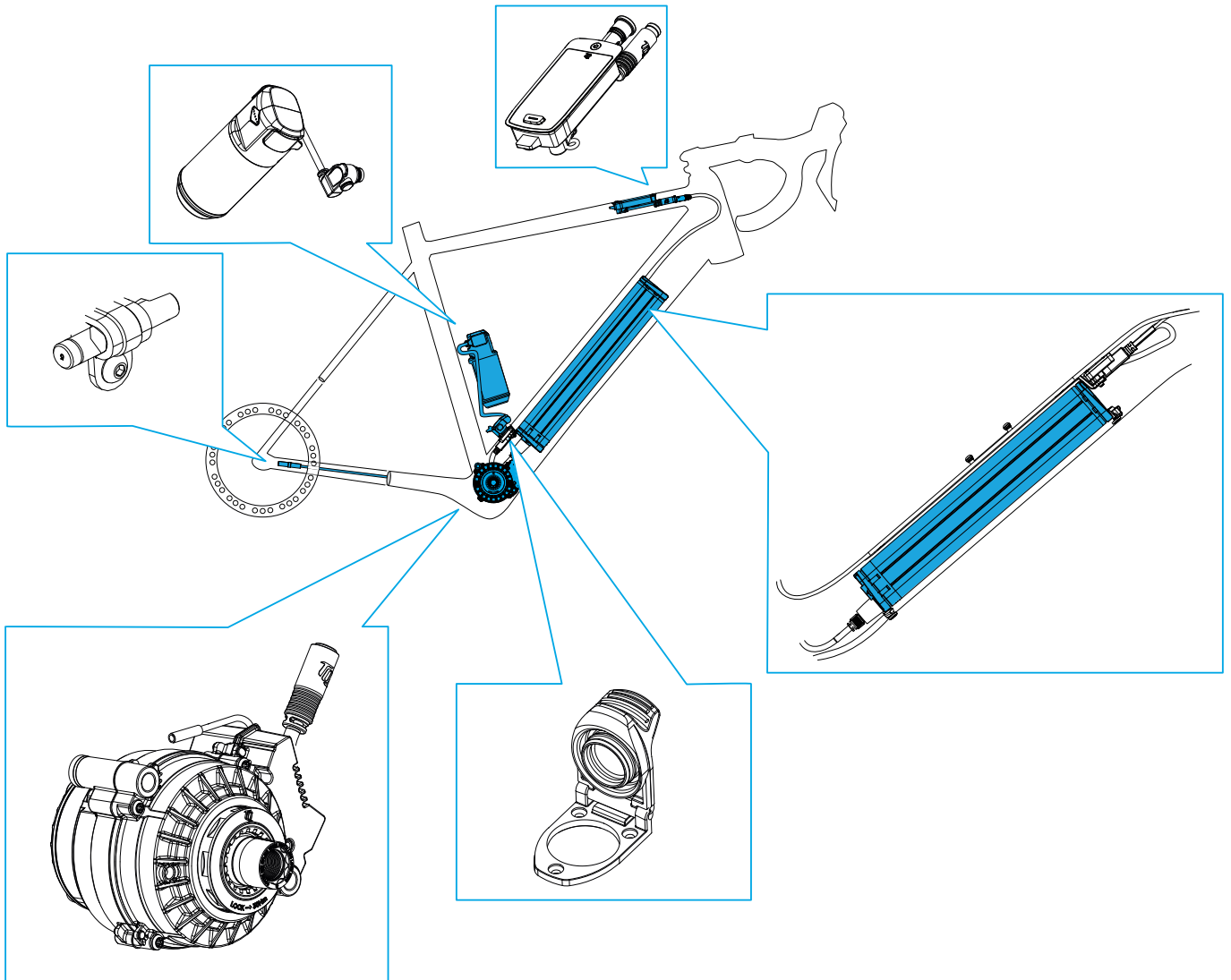

Overview of the tools used in the manual



Torque wrench



Caliper gauge



Inner bearing tool BB-UN55



Ball-bearing grease



Hex key 2.5 mm



Hex key 5 mm



Hex key 6 mm



Torx T8



Torx T10



Torx T20



Torx T25



Torx T45



Torx T55



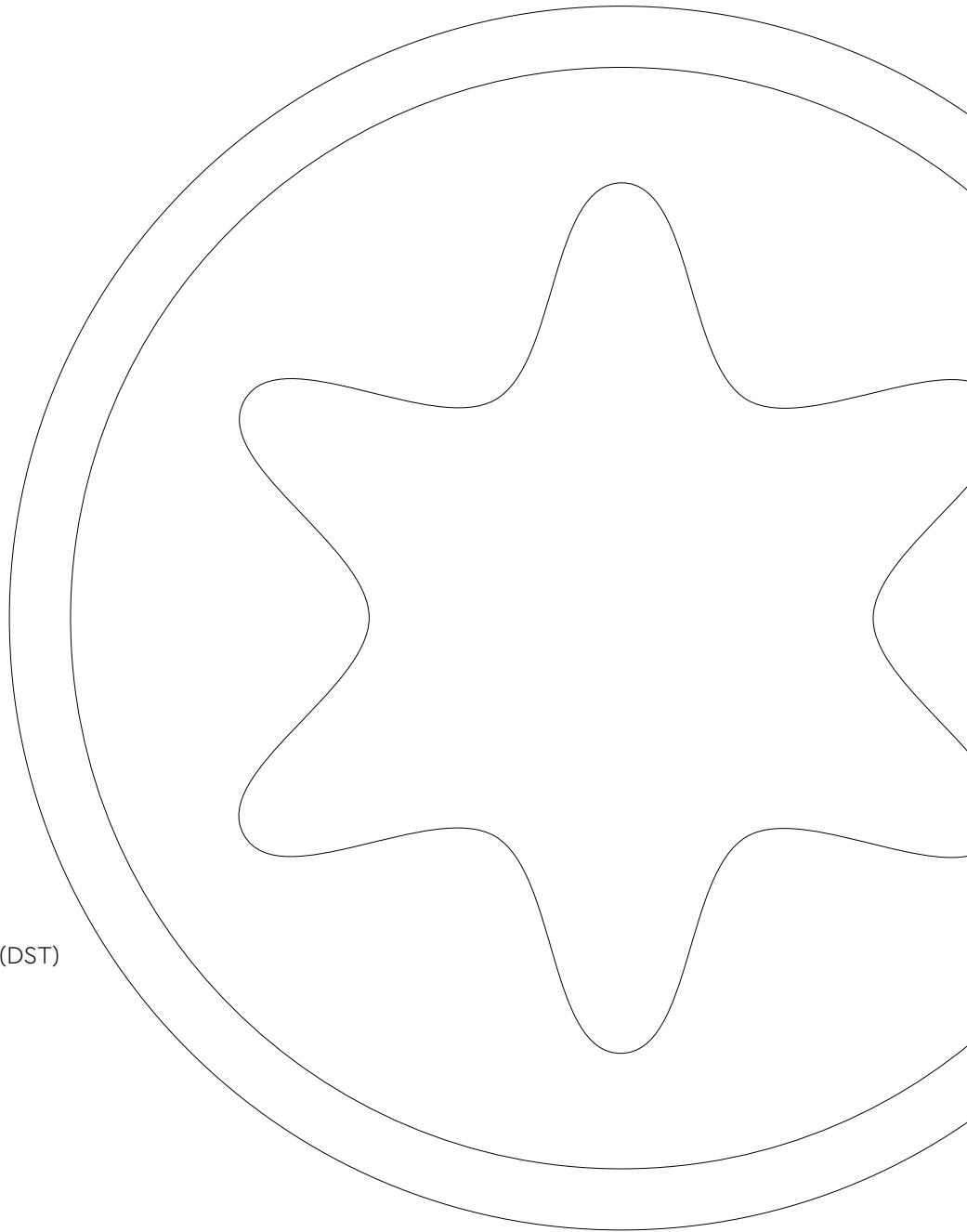

Dealer Service Tool (DST)



Installation of the display (V01 and V02)

Tool required

4	 Nm wrench	Torque wrench
4	 T10	Torx T10
5	 DST	Dealer Service Tool (DST)

Display installation

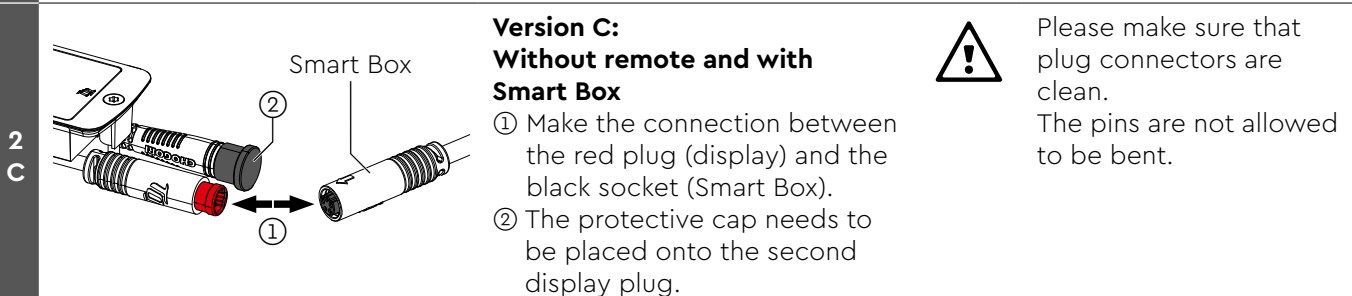
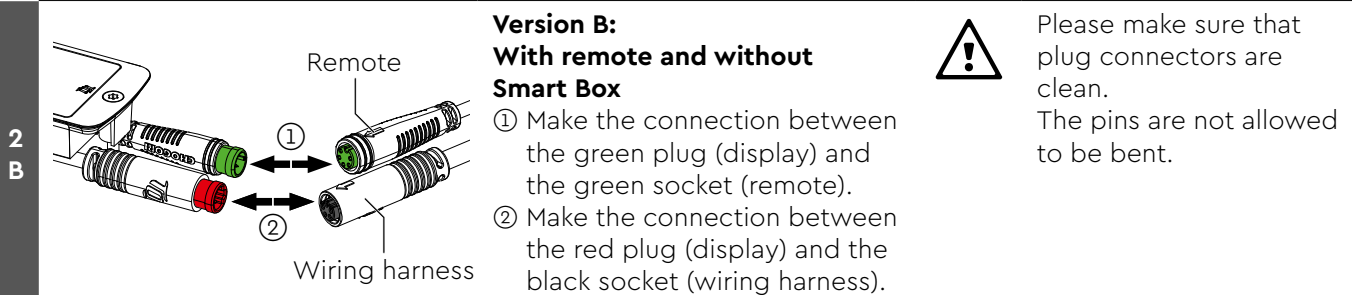
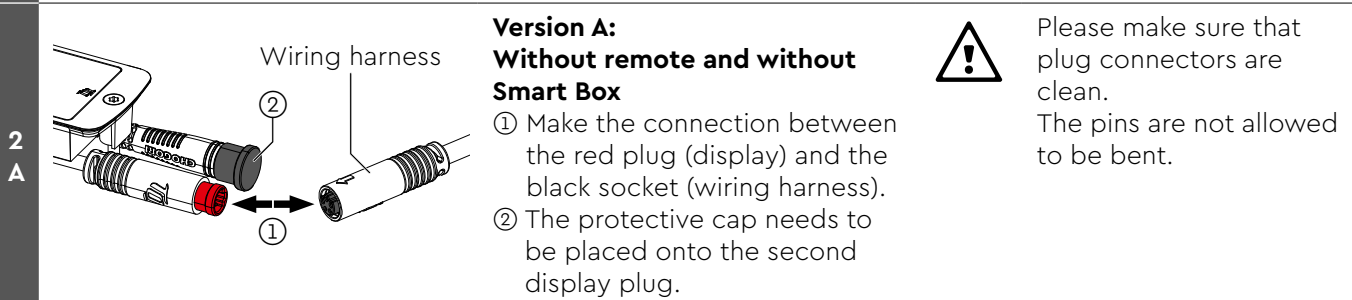
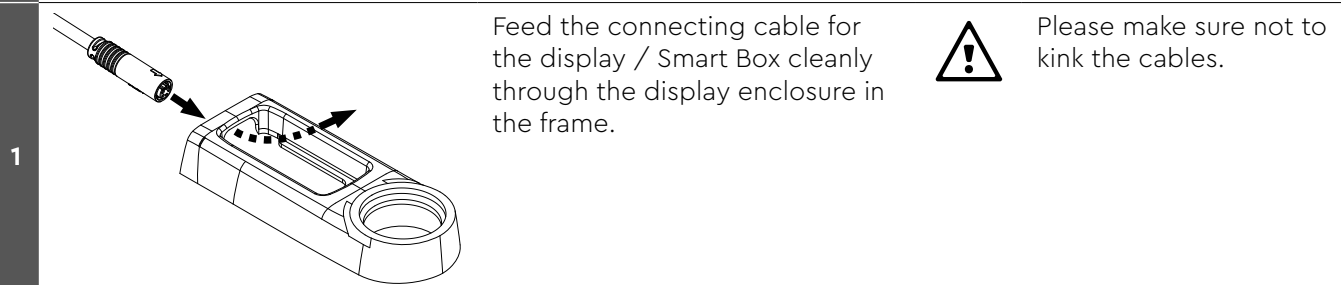
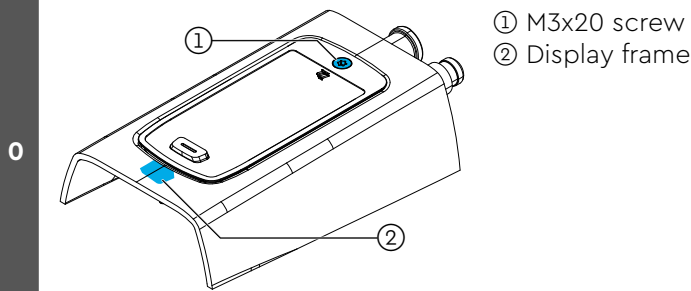

2
D

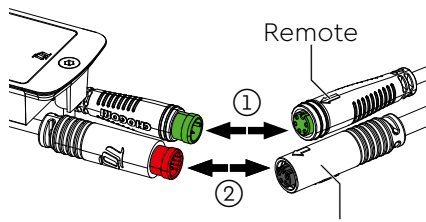

**Version D:
With remote and with smart
box**

- ① Make the connection between the green plug (display) and the green socket (remote).
- ② Make the connection between the red plug (display) and the black socket (Smart Box).



Please make sure that plug connectors are clean. The pins are not allowed to be bent.

3

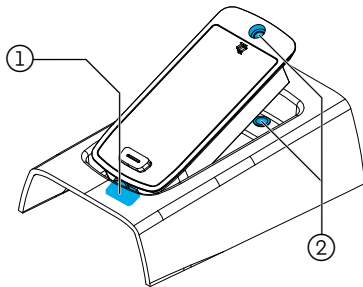

- ① Insert the display enclosure down into the frame.
- ② The screw hole in the display needs to be above the screw hole in the frame.

4

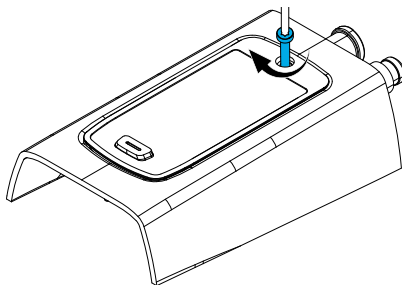

Tighten the included M3×20 display screw with a torque of 0.5 Nm.



0.5 Nm

5

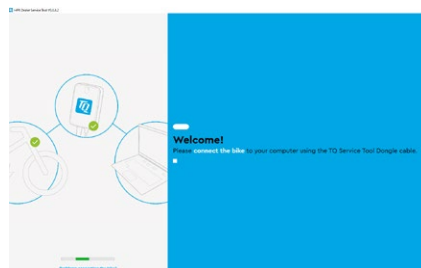

Launch the TQ Dealer Service Tool and connect the dongle with the PC and the bike.



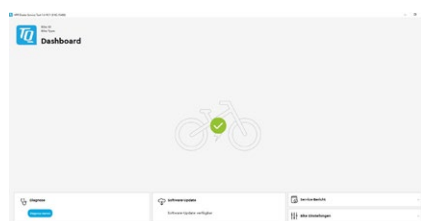

6











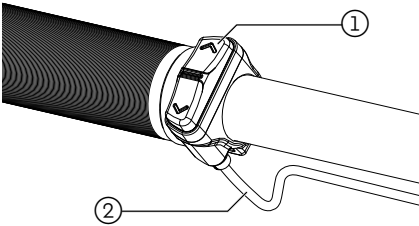
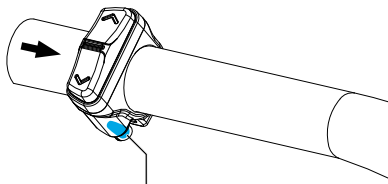

Perform available software updates in order to keep the system up to date.

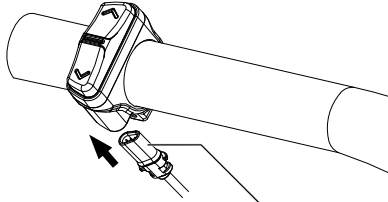
Assembly of the REMOTE V02

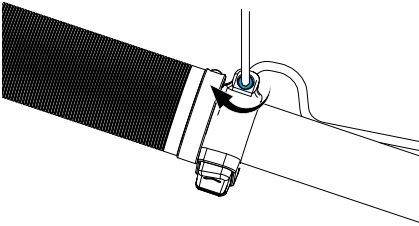



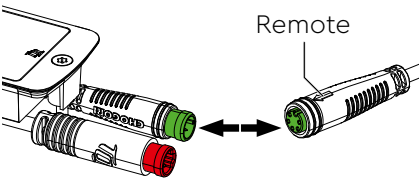

Tool required

3	 Nm wrench	Torque wrench
3	 2,5 mm	Hex key 2.5 mm

Remote assembly

0	 <p>① Remote control unit ② Remote cable</p>		
1	 <p>Remote cable socket</p>	Plug the remote control unit into the left handlebars.	 Makes sure it is properly aligned.
2	 <p>Remote cable plug</p>	Insert the oval plug of the remote cable properly aligned and all the way into the remote control unit. Feed the cable within the handlebars in the direction of the display.	 Pay attention to the oval coding of the plug. Please make sure that the plug connectors are clean, the pins are not allowed to be bent.
3		Tighten the pre-assembled M3 remote screw using a torque of 1 Nm.	  2,5 mm  Nm wrench 1 Nm
4	 <p>Remote</p>	Make the connection between the green socket (remote) and the green plug (display).	 Please make sure that the plug connectors are clean, the pins are not allowed to be bent.

Installation of Drive Unit HPR50

Tool required		
2	 caliper	Caliper gauge
2	 T55	Torx T55
4 6	 Nm wrench	Torque wrench
4	 6 mm	Hex key 6 mm
5	 grease	Multi-purpose grease
6	 BB UN55	BB-UN55 inner bearing tool
8	 DST	Dealer Service Tool (DST)

⚠ CAUTION

This label on the drive unit housing marks those which are compatible for TREK Slash+ only.



- Therefore do not assemble any TQ Drive Unit without „Slash+ only“ label in the Trek Slash+ bike with high pivot and do not assemble the Slash+ only Drive Unit in any regular HPR50 bikes either.

Motor installation

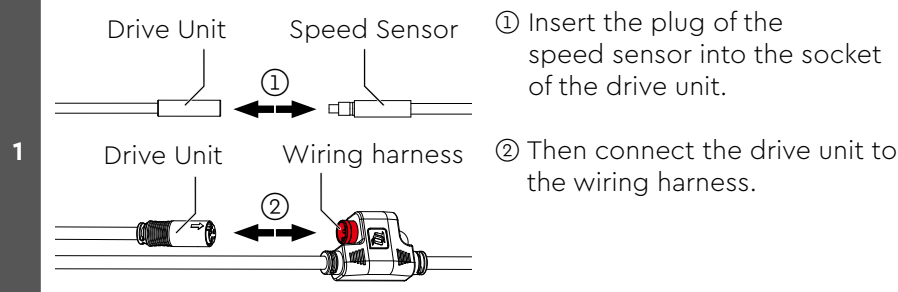
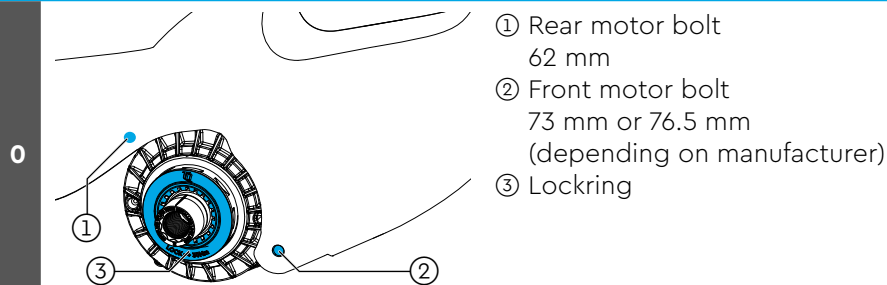

Pay attention to the coding of the plug. Please make sure that the plug connectors are clean, the pins are not allowed to be bent.

2

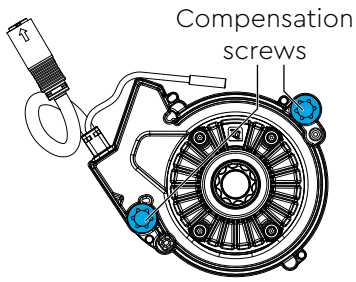

Adjust the two motor compensation screws to the correct frame width at the mounting points. Maximum axial frame tolerances of ± 1 mm can be compensated.



The two screws have a left-hand thread! Incorrectly adjusted screws may cause damage to the frame or drive unit!



Drives without compensation screws have a fixed installation dimension and may only be used for corresponding models.

2 A

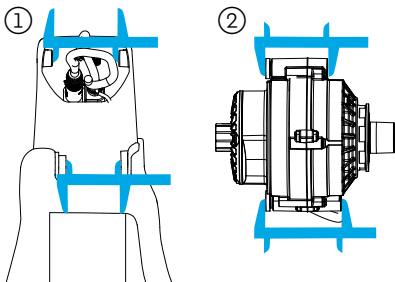

- ① Use a caliper gauge to measure the distance between the two mounting points in the frame.
- ② Then set this value on the motor compensation screws and thus adjust them to the required frame width.



The maximum motor compensation width is not allowed to exceed or fall below a maximum of ± 1 mm.

3

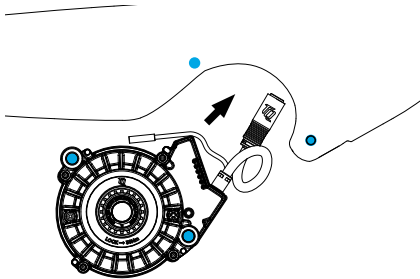

Insert the drive unit into the e-bike frame – matching the mounting points.



Make sure that no cables or plugs are crushed or kinked.

4

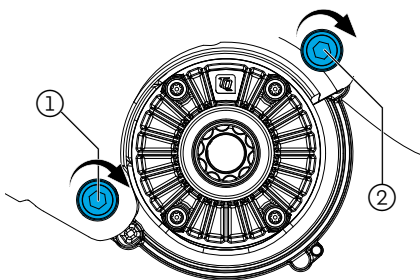

Tighten the motor bolts ① and ② according to the respective e-bike manufacturer with a tightening torque of 20 Nm. Use new motor bolts (using a medium-strength threadlocker if necessary)



20 Nm



Ensure that the contact surfaces are clean.

5

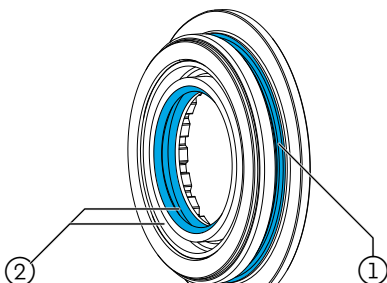

Prior to assembly of the lockring, grease the O ring ① and the shaft seal ② at the marked points with ball-bearing grease.





<p>6</p>		<p>Place the chain ring (manufacturer-dependent) on the output shaft.</p> <p>Attach the locking ring ① with the help of a mounting tool ② and tighten it with a tightening torque of 50 Nm.</p> <p>Then remove the mounting tool ②.</p>				<p>50 Nm</p>		<p>Mounting without a mounting tool can lead to damage of the shaft seal and thus to motor damage, e.g. due to water ingress!</p>
<p>7</p>		<p>Mount both cranks, taking into account the index markings.</p>		<p>Incorrect installation may result in the assistance not working properly, or not working at all.</p>				
<p>8</p>		<p>Launch the TQ Dealer Service Tool and connect the dongle with the PC and the bike.</p>						
<p>9</p>		<p>The Dealer Service Tool connects to the TQ database and identifies the e-system.</p> <p>Confirm the bike serial number; if identification is not possible, enter the serial/frame number.</p>						
<p>10</p>		<p>Perform available software updates in order to keep the system up to date.</p>						

NOTICE

Cross replacing for troubleshooting

- The drive unit cross replacing should only be performed for analysis or troubleshooting purposes. Permanent replacement can lead to errors in the app.

Installation of the Battery HPRV01

Tool required		
2 4		Torque wrench
2		Torx T10
4		Torx T25
additional tools may be required to remove the skid plate.		

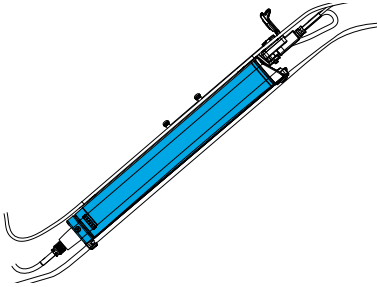
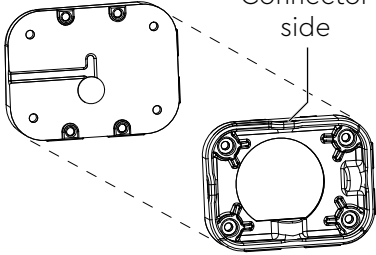
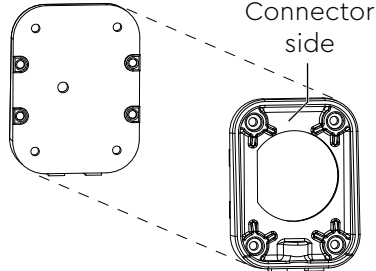
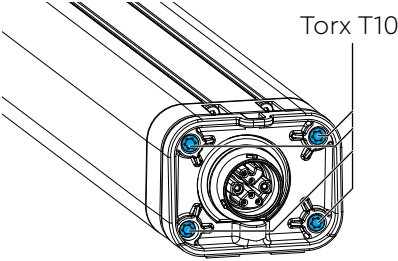
Battery installation		
0		Battery installed in the frame and connected.
1 A	 <p>Connector side</p>	<p>Select the manufacturer-dependent battery brackets and the recommended screws:</p> <p>The figure on the left shows the horizontal layout of the brackets.</p>
1 B	 <p>Connector side</p>	<p>The figure on the left shows the vertical layout of the brackets.</p>
2	 <p>Torx T10</p>	<p>Screw the two brackets to the battery with the ISO14580 M3×6 screws (with threadlockers) with a torque of 1 Nm.</p>











Please note the manufacturer-dependent horizontal or vertical design of the brackets.

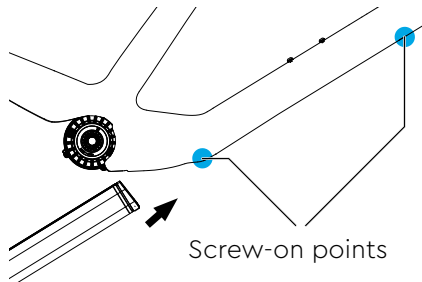

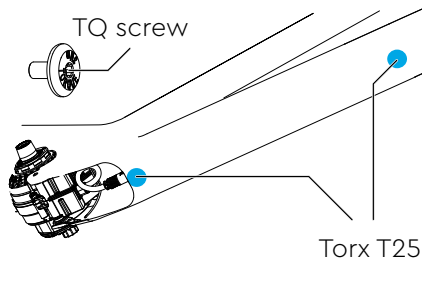

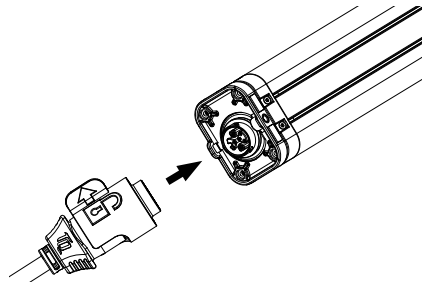

1 Nm









During installation, pay attention to the connector coding. (see Fig. left)



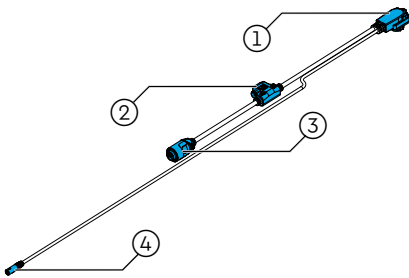
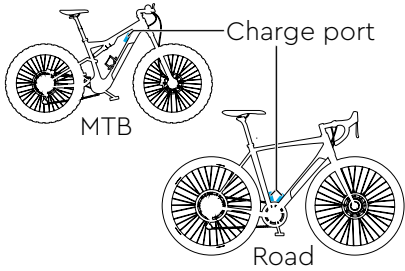
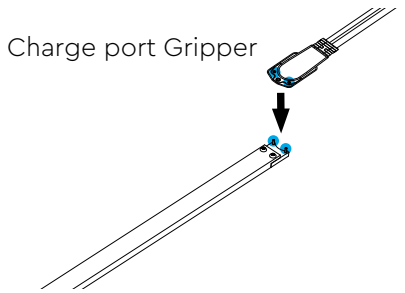

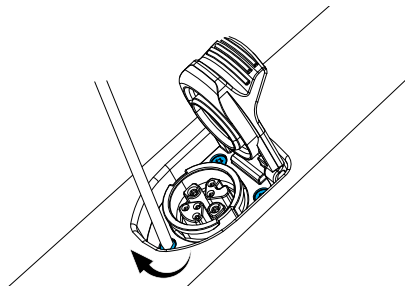





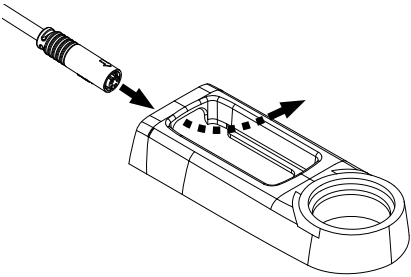

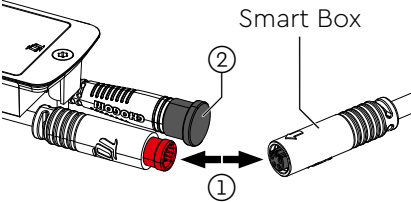
3	 <p>Screw-on points</p>	<p>Carefully slide the Battery V01 into the battery compartment up to the specified screw-on points.</p> <p>The wiring harness should already be pre-mounted. See also "Installing the wiring harness" on Page 20.</p>	 <p>Be careful not to crush any cables. Please observe the manufacturer-dependent instructions for the wiring harness.</p>
4	 <p>TQ screw</p> <p>Torx T25</p>	<p>Fasten the Battery V01 to the frame with the TQ screws (M5) provided for this purpose and tighten them with a tightening torque of 3 Nm.</p>	  <p>3 Nm</p>  <p>Note other manufacturer-dependent bracket/screw solutions, where applicable.</p>
5		<p>Connect the battery plug from the wiring harness to the battery.</p>	 <p>Ensure that the plug is properly locked. The plug snaps into place with a clicking sound.</p>
6		<p>Where appropriate, mount the drive unit see "Installation of Drive Unit HPR50" on Page 14 and/or the manufacturer-dependent skid plate.</p>	 <p>Observe the manufacturer's instructions for skid plate installation.</p>

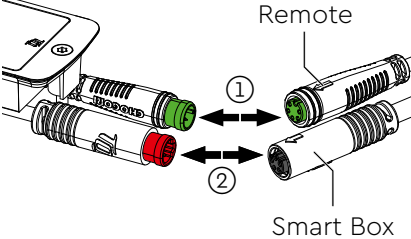
Installing the wiring harness

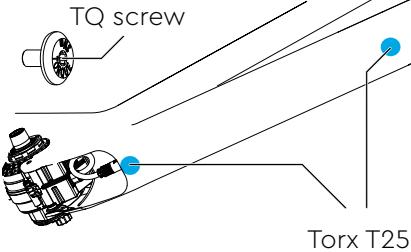

Tool required	
3	 Nm wrench Torque wrench
3	 T ₈ Torx T8
X	 T ₁₀ Torx T10
6	 T ₂₅ Torx T25
additional manufacturer-dependent tools may be required	

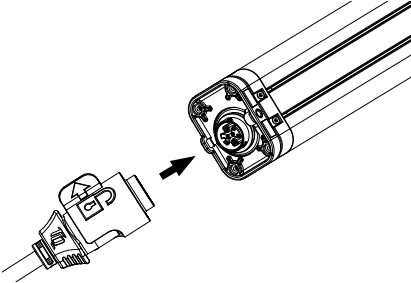
Wiring harness installation









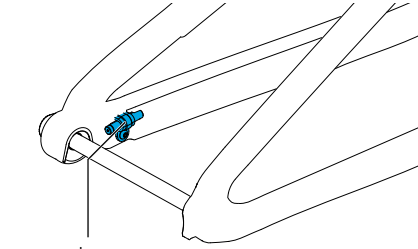
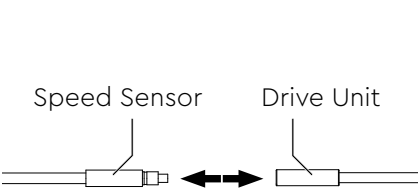

0	 <p>Interfaces of the wiring harness as seen on the "Road" version: ① Charge port ② Splitter ③ Battery connection ④ Display connector</p>	
1	 <p>Select the appropriate wiring harness: CAB01 MTB (position of charge port above the battery). CAB02 Road (position of charge port below the battery).</p>	
2	 <p>Use of the "charge port gripper" mounting tool:</p> <p>To guide the charge port at the MTB to the desired position, the charge port can be picked up via the two lugs and thus guided more easily to the appropriate position.</p>	 The charge port gripper is available separately in the TQ online store.
3	 <p>Position the charge port in the correct position in the frame using the charge port gripper (MTB) or by hand (Road).</p> <p>Then screw it on with the three M2.5×8 screws provided with a tightening torque of 0.8 Nm.</p>	  T ₈  Nm wrench 0.8 Nm  Pay attention to the manufacturer-dependent coding of the charging plug! This can be checked with the charging plug of the TQ charger prior to mounting.

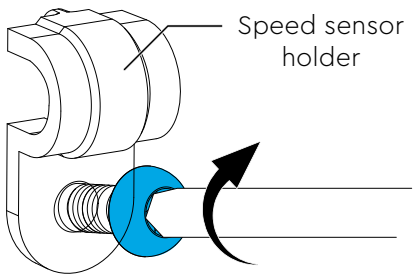
4		<p>Feed the connecting cable for the display / Smart Box cleanly through the display enclosure in the frame.</p>	 <p>Please make sure not to kink the cables.</p>
5 A		<p>Version A: Without remote and with Smart Box</p> <ol style="list-style-type: none"> ① Make the connection between the red plug (display) and the black socket (Smart Box). ② The protective cap needs to be placed onto the second display plug. 	 <p>Please make sure that plug connectors are clean. The pins are not allowed to be bent.</p>
5 B		<p>Version B: With remote and with Smart Box</p> <ol style="list-style-type: none"> ① Make the connection between the green plug (display) and the green socket (remote). ② Make the connection between the red plug (display) and the black socket (Smart Box). 	 <p>Please make sure that plug connectors are clean. The pins are not allowed to be bent.</p>
6		<p>Fasten the Battery V01 to the frame with the TQ screws (M5) provided for this purpose and tighten them with a tightening torque of 3 Nm.</p>	  <p>3 Nm</p>  <p>Note other manufacturer-dependent bracket/screw solutions, where applicable.</p>
7		<p>Connect the battery plug from the wiring harness to the battery.</p>	 <p>Ensure that the plug is properly locked. The plug snaps into place with a clicking sound.</p>
8	<p>Where appropriate, mount the drive unit (manufacturer-dependent) see "Installation of Drive Unit HPR50" on Page 14. Then connect the drive unit to the wiring harness.</p>		

Installation of the speed sensor

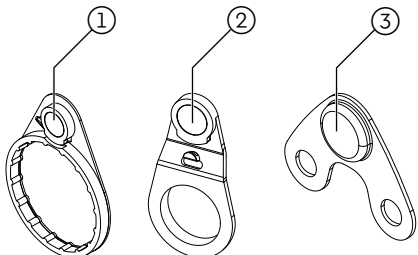
Tool required		
2	 Nm wrench	Torque wrench
2	 T ₂₀	Torx T20
3	 T ₂₅	Torx T25 for 6-hole magnet where applicable
additional manufacturer-dependent tools may be required		

Mounting the speed sensor

0		Speed sensor installed and connected to drive unit.	
1		Feed the plug-connection cable of the speed sensor through the frame and then connect it to the drive unit connection socket.	 Be careful not to crush any cables.
2		Now screw the speed sensor to the frame using the holder provided with a tightening torque of 0.8 Nm.	   0.8 Nm
3		Depending on the brake disc, select the appropriate magnet and attach it to the brake disc.	   The tool may differ depending on the manufacturer, please observe the torque specified by the manufacturer.



4

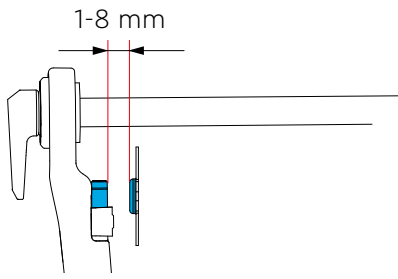



Check the air gap between the speed sensor and magnet. This must be 1-8 mm.



Installation of the Smart Box

Tool required

8		T 10	Torx T10
9		DST	Dealer Service Tool (DST)

Installation of the Smart Box

0

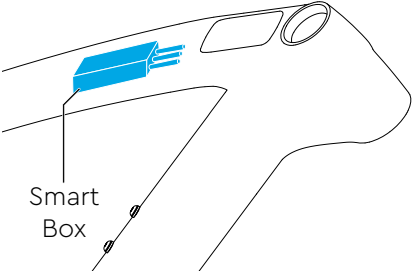

Smart Box

Smart Box installed and connected between the display and the wiring harness.

1

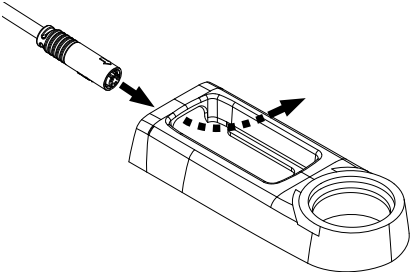

Feed the connecting cable for the display / Smart Box cleanly through the display enclosure in the frame.



Please make sure not to kink the cables.

2

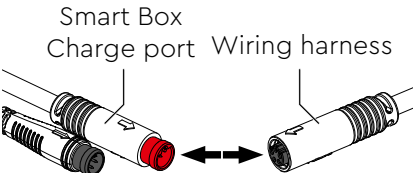

Smart Box Charge port Wiring harness

Connect the charge port cable at the Smart Box with the wiring harness.



Please make sure that plug connectors are clean. The pins are not allowed to be bent.

3

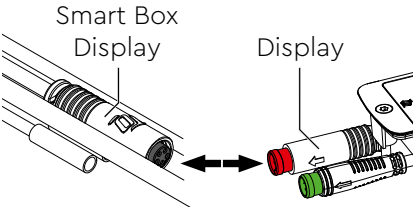

Smart Box Display Display

Connect the "display" cable at the Smart Box with the display connector.



Please make sure that plug connectors are clean. The pins are not allowed to be bent.

4

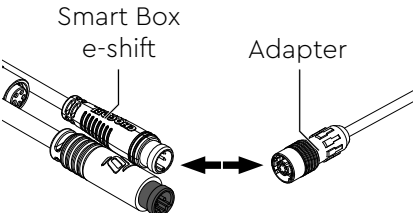

Smart Box e-shift Adapter

Optional:
Connect the "e-shift" cable at the Smart Box with the electric gear shift. To do so, use the adapter cables supplied by TQ for Shimano DI2 or SRAM AXS.



Please make sure that plug connectors are clean. The pins are not allowed to be bent.

5

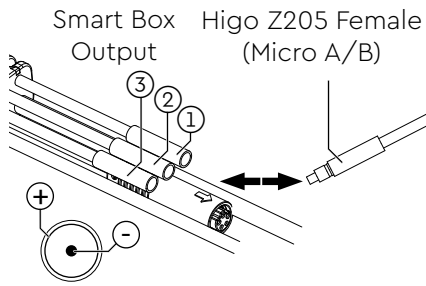

For example, connect the lighting to Output 2 or Output 3 on the Smart Box via compatible Higo Z205 Micro Female connectors. Output 1 is not short-circuit proof.



Please make sure that plug connectors are clean. The pins are not allowed to be bent.

Compatible lights/Higo Micro adapters can be purchased from supernova-lights.com or lupine.de, for example.

The **maximum power** for external consumers (front and rear light etc.) **is not allowed to exceed 26 W at 13.2 V.**

6

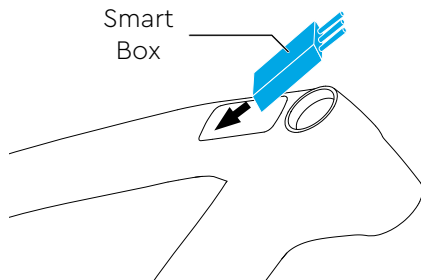

Insert the Smart Box into the display enclosure. To do so, first insert the cables into the display enclosure.



Be careful not to crush any cables or plugs.

If necessary, the Smart Box must be secured against rattling.

7

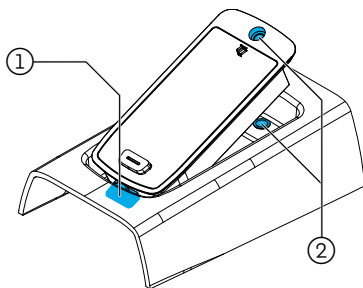

- ① Insert the display enclosure down into the frame.
- ② The screw hole in the display needs to be above the screw hole in the frame.

8

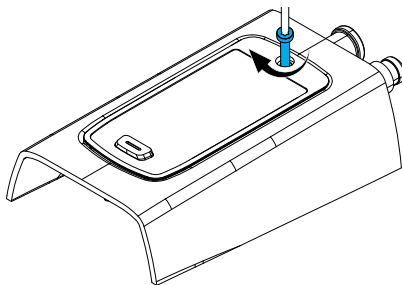

Tighten the included M3×20 display screw with a torque of 0.5 Nm.



0.5 Nm

9

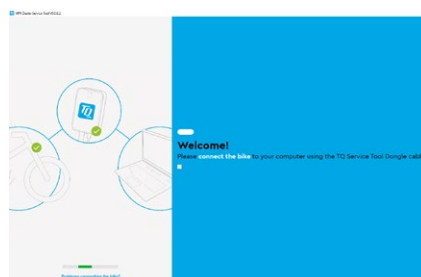

Launch the TQ Dealer Service Tool and connect the dongle with the PC and the bike.



10

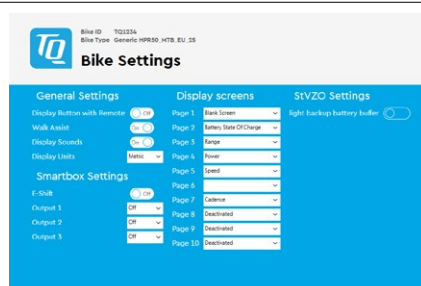

Under the menu item "Bike Settings", the required outputs for the electronic circuitry or the lighting can now be enabled.



The **maximum power** for external consumers (front and rear light etc.) **is not allowed to exceed 26 W at 13.2 V.**

Installation of the Y-splitter (AUX and AXS)

Tool required

7  T₁₀ Torx T10

Installation of the Y-splitter (AUX and AXS)

0

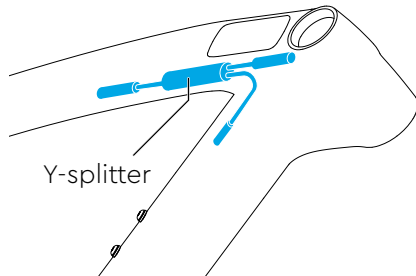

Y-splitter installed and connected between display and harness.



Be sure to select the correct Y-splitter **AUX** or **AXS**.

1

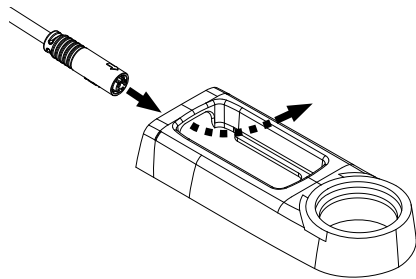

Feed the connection cable for the display / Y-splitter cleanly through the display pocket in the frame.



Please make sure not to kink the cables.

2

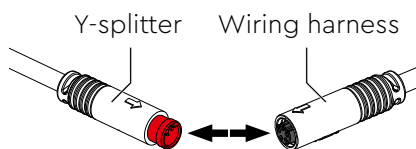

Connect the Y-splitter to the wiring harness.



Please make sure that plug connectors are clean. The pins are not allowed to be bent.

3
A

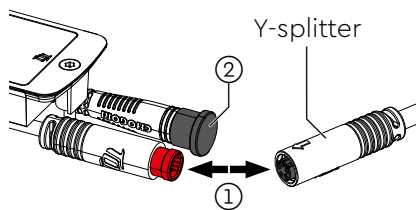

Variant A: Without remote and with Y-splitter

- ① Establish the plug connection between the red plug (display) and the black socket (Y-splitter).
- ② The protective cap must be inserted on the second display plug.



Please make sure that plug connectors are clean. The pins are not allowed to be bent.

3
B

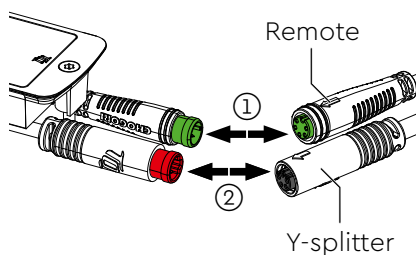

Variant B: With remote and with Y-splitter

- ① Establish the plug connection between green plug (display) and green socket (remote).
- ② Establish the plug connection between red plug (display) and black socket (Y-splitter).



Please make sure that plug connectors are clean. The pins are not allowed to be bent.

<p>4 A</p>		<p>AUX Connect the cable to the Higo Z205 Female (Micro A/B) connector for example with compatible light.</p>	<p> Please make sure that plug connectors are clean. The pins are not allowed to be bent.</p> <p>The maximum power for external consumers (front and rear light etc.) is not allowed to exceed 26 W at 13.2 V.</p>
<p>4 B</p>		<p>AXS Connect the cable with the Higo Z205 Male (Micro A) connector to compatible SRAM AXS adapter cables (circuits).</p>	<p> Please make sure that plug connectors are clean. The pins are not allowed to be bent.</p>
<p>5</p>		<p>Insert the Y-splitter into the display pocket. First insert the cables into the display pocket.</p>	<p> Take care not to crush any cables or plugs. If necessary, the Y-splitter must be secured against rattling.</p>
<p>6</p>		<ol style="list-style-type: none"> ① Insert the display enclosure down into the frame. ② The screw hole in the display needs to be above the screw hole in the frame. 	
<p>7</p>		<p>Tighten the included M3×20 display screw with a torque of 0.5 Nm.</p>	<p> Nm wrench</p> <p>0,5 Nm</p>

Manual Dealer Service Tool (DST)

DST

1

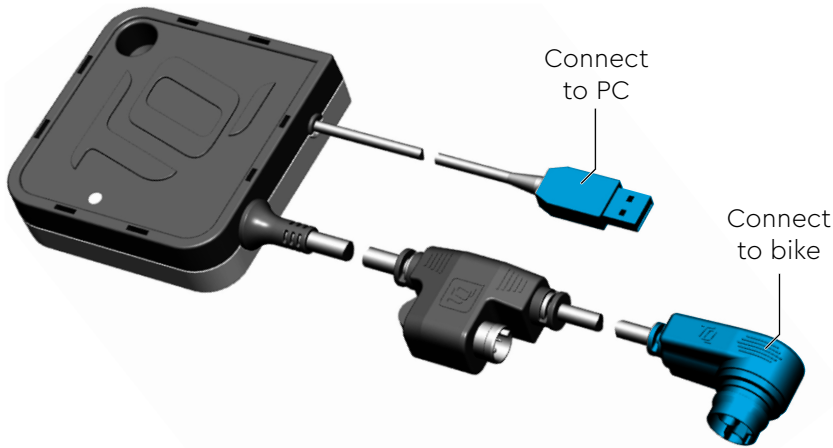

Connect the Dealer Service Tool to the PC via USB port and to the bike via the charging port.

2

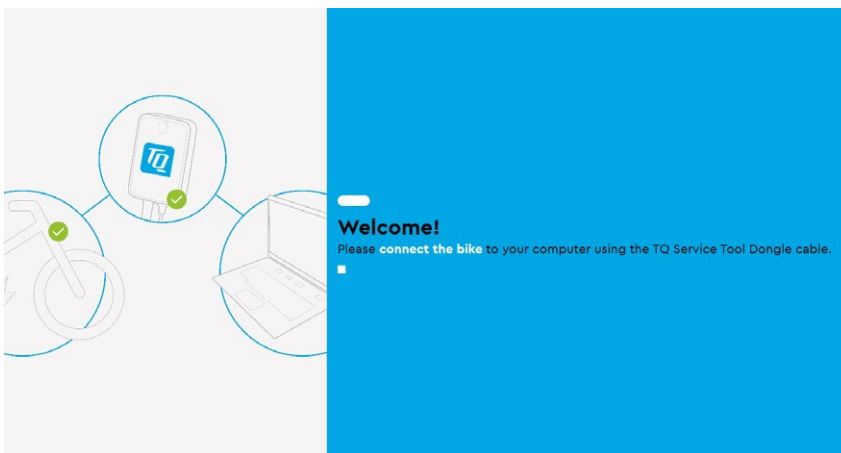

Now establish the connection in the DST software.

3

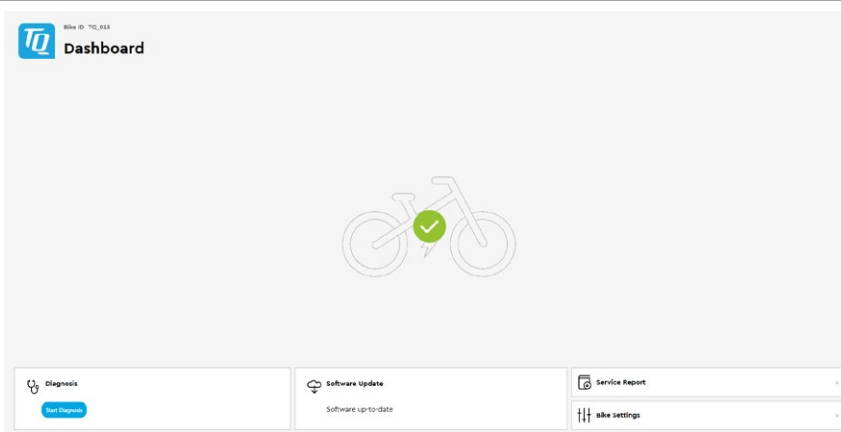

After the system has been successfully connected, you can access the "Diagnostics", "Software Update", "Service Report" and "Bike Settings" options.



4

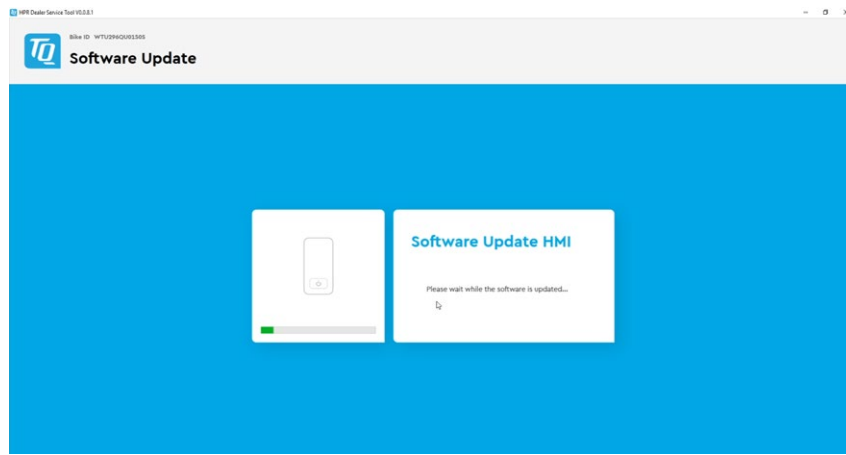

If updates are available, they are automatically uploaded to the components.

5

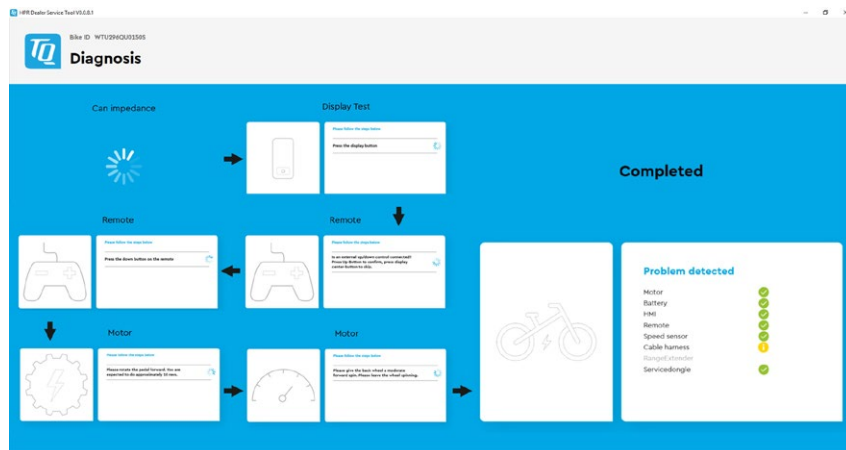

After calling up the diagnostics, various functions are checked and the result of the test is then clearly displayed.

6

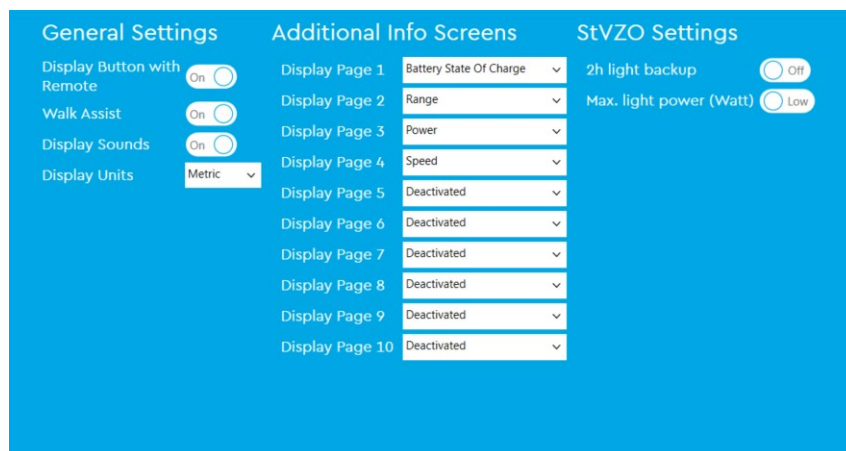

The following things can be configured under "Bike Settings":

General Settings

- Remote connected?
- Walk assist ON/OFF
- Noise when display key is pressed Display
- Display units (metric – imperial)

Additional info screens

see screenshot on the left

Road Traffic Licensing Regulations (StVZO) Settings

Enable 2 h residual illumination lighting time (German law) and set the light intensity

7

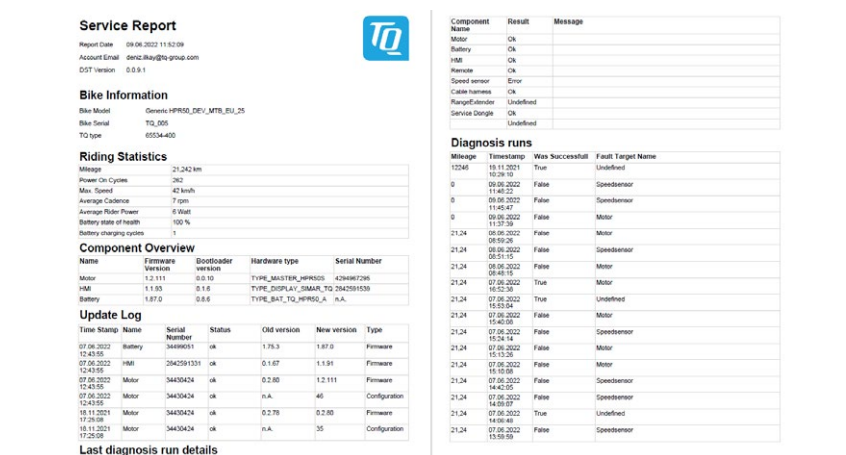

The Service Report is a summary of the most important information:

- Generation of report and user information
- Information about the bike (model, serial number and TQ type, if applicable)
- Cycling statistics
- Component overview with software versions and service number
- An update log with date and software version

The report can be exported as a PDF and made available to the customer.

Troubleshooting

Connect service tool and launch diagnostics.

Important notice: A software update must be performed after each component swap.

Error code	Cause	Remedy
ERR 0401 DRV SW	General software error	<ol style="list-style-type: none"> 1. Reboot the system 2. In case of outdated firmware, please perform a software update
ERR 0403 DRV COMM	Peripheral Communication Error	<ol style="list-style-type: none"> 1. Reboot the system 2. In case of outdated firmware, please carry out a software update
ERR 0405 DISP COMM	Walk assist Communication Error	<ol style="list-style-type: none"> 3. Check peripheral components for wire breaks, along with cable and plug connections 4. Remove third-party component
ERR 0407 DRV SW	Electronics fault in drive unit	<ol style="list-style-type: none"> 1. Reboot the system 2. In case of outdated firmware, please perform a software update
ERR 0408 DRV HW	Drive unit overcurrent fault	<p>Unintended use! Avoid extraordinary cycling situation to the extent possible. In case of outdated firmware, please perform a software update.</p> <ol style="list-style-type: none"> 1. Reboot the system 2. Replace motor if error occurs during start
ERR 040B DRV SW	General software error	<ol style="list-style-type: none"> 1. Reboot the system 2. In case of outdated firmware, please perform a software update
ERR 040C DRV SW		
ERR 040D DRV SW		
ERR 040E DRV SW		
ERR 040F DRV SW		
ERR 0415 DRV SW	Configuration error	Update not performed properly. Please perform a software update.
ERR 0416 BATT COMM	General software error	<ol style="list-style-type: none"> 1. Reboot the system 2. In case of outdated firmware, please perform a software update 3. Check peripheral components for wire breaks, along with cable and plug connections 4. Remove third-party component 5. Replace battery
ERR 0418 DISP COMM	Initialization error in display	<ol style="list-style-type: none"> 1. Reboot the system 2. In case of outdated firmware, please perform a software update 3. Check peripheral components for wire breaks, along with cable and plug connections 4. Remove third-party component 5. Replace display 6. Replace wiring harness
ERR 041D DRV HW	Drive unit memory error	<ol style="list-style-type: none"> 1. Reboot the system 2. In case of outdated firmware of the motor, please perform a software update 3. Replace motor
ERR 041D DRV SW		
ERR 042B DRV SW	General software error	<p>Outdated firmware</p> <ol style="list-style-type: none"> 1. Please perform a software update 2. Replace motor
ERR 042E DRV SW		
ERR 0440 DRV HW	Electronics fault in drive unit	<ol style="list-style-type: none"> 1. Reboot the system 2. Replace motor

Error code	Cause	Remedy
ERR 0445 DRV HW	Motor overcurrent fault	Unintended use! Avoid extraordinary cycling situation to the extent possible. 1. Reboot the system 2. Replace motor if error occurs during start
ERR 0451 DRV HOT ERR 0452 DRV HOT	Motor overtemperature fault	The motor has risen above or fallen below the permissible operating temperature. Avoid extraordinary cycling situation to the extent possible. 1. Switch off the drive to allow it to cool down if necessary 2. Reboot the system 3. Replace motor if error occurs during start
ERR 0453 DRV SW	Motor initialization error	1. Reboot the system 2. In case of outdated firmware, please perform a software update
ERR 0457 BATT CONN	Motor voltage error	Connection problem between engine and battery 1. Reboot the system 2. In case of outdated firmware, please perform a software update 3. Check peripheral components for wire breaks, along with cable and plug connections 4. Remove third-party component 5. Replace battery 6. Replace motor
ERR 0458 BATT CONN	Motor overvoltage error	Defective or incorrect charger 1. Check charger or use approved charger 2. Replace motor if error occurs during start
ERR 045D BATT GEN	General battery error	1. Reboot the system 2. In case of outdated firmware, please perform a software update
ERR 0465 BATT COMM	Battery communication error timeout	3. Replace battery
ERR 0469 BATT GEN	Critical battery fault	
ERR 0475 BATT COMM	Battery initialization error	
ERR 0477 DRV SW	Software Drive Unit configuration incorrect	Software update interrupted or configuration error during flashing 1. Please perform software update 2. Replace motor if error occurs at startup
ERR 0479 DRV SW ERR 047A DRV SW ERR 047B DRV SW	General software error	Update not performed properly 1. Reboot the system 2. Please perform a software update
ERR 047D DRV HW	Motor overcurrent fault	Unintended use! Avoid extraordinary cycling situation to the extent possible 1. Reboot the system 2. In case of outdated firmware, please perform a software update 3. Replace motor if error occurs during start
ERR 047F DRV HOT	Drive unit overtemperature error	The motor has risen above or fallen below the permissible operating temperature. Avoid extraordinary cycling situation to the extent possible. 1. Switch off the drive to allow it to cool down if necessary 2. Reboot the system 3. In case of outdated firmware, please perform a software update 4. Replace motor if error occurs during start
ERR 0480 DRV SENS	Drive unit assistance fault	Unintended use! Avoid extraordinary cycling situation to the extent possible. 1. Reboot the system 2. In case of outdated firmware, please perform a software update 3. Replace motor if error occurs during start
ERR 0481 BATT COMM	Battery communication error	1. Reboot the system 2. Please perform a software update

Troubleshooting

Error code	Cause	Remedy
ERR 0482 DRV SW	Drive unit calibration error	Update not performed properly 1. Reboot the system 2. Please perform a software update
ERR 0483 DRV SW	Software runtime error	Outdated motor firmware 1. Reboot the system 2. Please perform a software update
ERR 0484 DRV SW		
ERR 0485 DRV SW		
ERR 0486 DRV SW		
ERR 0487 DRV SW		
ERR 0488 DRV SW		
ERR 0489 DRV SW		
ERR 048A DRV SW		
ERR 048B DRV SW		
ERR 048C DRV SW		
ERR 048D DRV SW		
ERR 048E DRV SW		
ERR 048F DRV SW		
ERR 0490 DRV SW		
ERR 0491 DRV SW		
ERR 0492 DRV SW		
ERR 0493 DRV HW	Drive unit voltage error	1. Reboot the system 2. Replace motor if error occurs during start
ERR 0494 DRV HW	Problem with supply voltage	
ERR 0495 DRV HW	Drive unit voltage error	
ERR 0496 DRV HW	Drive unit phase break	
ERR 0497 DRV HW	Drive unit calibration error	
ERR 04C8 DRV SW	General software error	Outdated motor firmware 1. Reboot the system 2. Please perform a software update
ERR 0498 DRV COMM	Peripheral communication error	Outdated firmware of peripheral components 1. Reboot the system 2. Please perform a software update 3. Remove third-party component
ERR 0499 DRV COMM		
ERR 049A DRV COMM		
ERR 049B DRV SENS	Cadence sensor error	1. Reboot the system 2. In case of outdated firmware, please perform a software update 3. Replace motor
ERR 049C DRV SENS	Torque sensor error	Unintended use! Avoid extraordinary cycling situation to the extent possible. 1. Reboot the system 2. Replace motor if error occurs during start
ERR 049D DRV SENS		
ERR 049E DRV SENS		
ERR 049F DRV SENS		
ERR 04A0 DRV COMM		
ERR 04A1 DRV COMM		
ERR 04A2 DRV COMM	Microcontroller electronics error	1. Reboot the system 2. Replace motor
ERR 04A3 DRV SW	Cadence sensor error	1. Reboot the system 2. In case of outdated firmware, please perform a software update
ERR 04A4 DRV HW		
ERR 04A5 DRV SW	Torque sensor error	3. Replace motor

Error code	Cause	Remedy
ERR 04A6 BATT COMM	Battery communication error	Connection problem between engine and battery 1. Reboot the system 2. In case of outdated firmware, please perform a software update 3. Remove third-party component 4. Replace battery
ERR 04A7 DRV SW	General software error	Outdated motor firmware 1. Reboot the system 2. Please perform a software update
ERR 04A8 SPD SENS	Speed sensor error	1. Check speed sensor 2. Ensure permissible clearance of the spoke magnet to the speed sensor or check for tampering
ERR 04A9 DRV SW ERR 04AA DRV SW	General software error	Outdated motor firmware 1. Reboot the system 2. Please perform a software update
WRN 04AB DRV SENS	Cadence sensor error	1. Reboot the system 2. In case of outdated firmware, please perform a software update 3. Replace motor
ERR 04AD DRV SW	Drive unit control error	Outdated motor firmware 1. Reboot the system 2. Please perform a software update
ERR 04AE DRV SW ERR 04AF DRV SW	Cadence sensor error	1. Reboot the system 2. Replace motor if error occurs during start
ERR 04B0 DRV HW	Drive unit mechanical error	Unusual use of the walk assist/ Locking rotor 1. Check if something is jammed or wedged in the chain ring 2. Walk assist needs to be pushed more strongly by the user 3. Replace motor
ERR 04C8 DRV SW ERR 04C9 DRV SW ERR 04CA DRV SW ERR 04CB DRV SW	General software error	Outdated motor firmware 1. Reboot the system 2. Please perform a software update
WRN 0601 SPD SENS	Speed sensor problem	Missing or defective speed sensor 1. Ensure permissible clearance of the spoke magnet to the speed sensor 2. Reboot the system 3. Replace speed sensor
WRN 0602 DRV HOT	Drive unit overtemperature	Permissible operating temperature exceeded. Avoid extraordinary cycling situation to the extent possible. 1. Switch off the drive to allow it to cool down if necessary 2. Reboot the system 3. In case of outdated firmware, please perform a software update 4. Replace motor if error occurs during start
WRN 0603 DRV COMM	CAN bus communication problem	Soiling or water in plug connectors. Connection problems in the wiring harness. Electronics fault in one of the components. 1. Check charging port for soiling 2. Reboot the system 3. In case of outdated firmware, please perform a software update 4. Check peripheral components for wire breaks, along with cable and plug connections
WRN 0604 DRV UPDT	Encoder update from Torquesensor	1. Wait approx. 1 minute and do not switch off the system so that the update can be performed. 2. Replace motor if error occurs at startup

Troubleshooting

Error code	Cause	Remedy
WRN 0605 SPD SENS	Speedsensor problem	Missing or defective speedsensor <ol style="list-style-type: none"> 1. Ensure permissible distance of the magnet to the speedsensor 2. Please perform software update 3. Replace speedsensor
ERR 4401 BATT HW	Battery hardware failure	<ol style="list-style-type: none"> 1. Reboot the system 2. Battery plug correctly inserted, check for cable break and contamination 3. Replace wiring harness 4. Exchange Battery
ERR 4403 BATT HW		
ERR 4404 BATT SW	Battery – CAN initialization not possible	<ol style="list-style-type: none"> 1. Reboot the system 2. Exchange Battery
ERR 4405 BATT HW	Battery hardware failure	
ERR 4407 BATT OV	Battery cell voltage too high	
ERR 4408 BATT OV		
ERR 4409 BATT HW	Battery deep discharged or defect cell	<ol style="list-style-type: none"> 1. Charge Battery immediately 2. Reboot the system 3. Exchange Battery
ERR 440A BATT UV	Battery voltage too low	<ol style="list-style-type: none"> 1. Charge Battery immediately 2. Exchange Battery
ERR 440C BATT OV	Battery voltage too high	<ol style="list-style-type: none"> 1. Reboot the system 2. Exchange Battery
ERR 440E BATT GEN	Battery short circuit	
ERR 440F BATT UV	Battery voltage too less	<ol style="list-style-type: none"> 1. Charge Battery immediately 2. Exchange Battery
ERR 4410 BATT HW	Battery cell difference too high	<ol style="list-style-type: none"> 1. Reboot the system 2. Exchange Battery
ERR 4411 BATT UV	Battery voltage too less	<ol style="list-style-type: none"> 1. Charge Battery immediately 2. Exchange Battery
ERR 4412 BATT OV	Battery voltage too high	<ol style="list-style-type: none"> 1. Reboot the system 2. Exchange Battery
ERR 4414 BATT HW	Battery cell difference measurement too high	<ol style="list-style-type: none"> 1. Reboot the system 2. Please perform software update (at least version 1.99.5) 3. Exchange Battery
ERR 4415 BATT UV	Battery voltage too less	<ol style="list-style-type: none"> 1. Reboot the system 2. Exchange Battery
ERR 4416 BATT HW	Battery charging not possible	
ERR 4417 BATT HW	Battery cell voltage too less	
ERR 4418 BATT HW	Battery hardware failure	
ERR 4419 BATT HW		
ERR 441B BATT HW	Battery cell temperature deviation	<ol style="list-style-type: none"> 1. Cool down or warm up the Battery to room temperature 2. Reboot the system 3. Exchange Battery
ERR 441C BATT HOT	Battery cell temperature too high	<ol style="list-style-type: none"> 1. Cool down the Battery to room temperature 2. Reboot the system 3. Exchange Battery
ERR 441D BATT COLD	Battery cell temperature too low	<ol style="list-style-type: none"> 1. Warm up the Battery to room temperature 2. Reboot the system 3. Exchange Battery
ERR 441E BATT HOT	Battery cell temperature too high	<ol style="list-style-type: none"> 1. Cool down the Battery to room temperature 2. Reboot the system 3. Exchange Battery
ERR 441F BATT COLD	Battery cell temperature too low	<ol style="list-style-type: none"> 1. Warm up the Battery to room temperature 2. Reboot the system 3. Exchange Battery
ERR 4420 BATT HOT	Battery cell temperature too high	<ol style="list-style-type: none"> 1. Cool down the Battery to room temperature 2. Reboot the system 3. Exchange Battery
ERR 4421 BATT HOT		

Error code	Cause	Remedy
ERR 4422 BATT COLD	Battery cell temperature too low	<ol style="list-style-type: none"> 1. Warm up the Battery to room temperature 2. Reboot the system 3. Exchange Battery
ERR 4423 BATT COLD		
ERR 4424 BATT HW	Battery hardware failure	<ol style="list-style-type: none"> 1. Reboot the system 2. Exchange Battery
ERR 4428 BATT HW		
ERR 4429 BATT HW		
ERR 442A BATT HW		
ERR 442B BATT HW		
ERR 442C BATT HW		
ERR 442D BATT HW	Battery hardware failure	<ol style="list-style-type: none"> 1. Reboot the system 2. Battery plug correctly inserted, check for cable break and contamination 3. Replace wiring harness 4. Exchange Battery
ERR 442F BATT HOT		
ERR 442F BATT HOT	Battery temperature too high	<ol style="list-style-type: none"> 1. Cool down the Battery to room temperature 2. Reboot the system 3. Exchange Battery
ERR 4430 BATT HW		
ERR 4431 BATT HW	Battery hardware failure	<ol style="list-style-type: none"> 1. Reboot the system 2. Exchange Battery
ERR 4432 BATT HW		
ERR 4433 BATT HW		
ERR 4434 BATT HW		
ERR 4435 BATT HW		
ERR 4436 BATT HW		
ERR 4436 BATT HW	Battery hardware failure	<ol style="list-style-type: none"> 1. Reboot the system 2. Battery plug correctly inserted, check for cable break and contamination 3. Replace wiring harness 4. Exchange Battery
ERR 4437 BATT HW		
ERR 4439 BATT HW	Battery hardware failure	<ol style="list-style-type: none"> 1. Reboot the system 2. Exchange Battery
ERR 443A BATT GEN		
ERR 443B BATT GEN	Battery charge overcurrent	
ERR 443D BATT HW	Battery discharge overcurrent	
ERR 443E BATT GEN	Battery hardware failure	
ERR 443F BATT GEN	Battery overcurrent	
ERR 4441 BATT HW	Battery hardware failure	
ERR 4442 BATT HW		
ERR 4443 BATT HW		
ERR 4444 BATT HW		
ERR 4446 BATT HW		
ERR 4447 BATT HW		
ERR 4448 BATT HW		
ERR 4449 BATT SW		
ERR 444B BATT HW		
ERR 4450 BATT OV	Battery cell voltage too high	<ol style="list-style-type: none"> 1. Reboot the system 2. Exchange Battery
ERR 4455 BATT HW	Battery hardware failure	<ol style="list-style-type: none"> 1. Reboot the system 2. Exchange Battery
ERR 4462 BATT HW		
ERR 4463 BATT HW		
ERR 4464 BATT HW	Battery reference voltage too high	<ol style="list-style-type: none"> 1. Reboot the system 2. Exchange Battery

Error code	Cause	Remedy
ERR 446C BATT HW	Battery hardware failure	<ol style="list-style-type: none"> 1. Reboot the system 2. Exchange Battery
ERR 446E BATT HW		
ERR 4471 BATT HW		
ERR 4472 BATT HW		
ERR 4473 BATT HW		
ERR 4474 BATT HOT	Battery temperature too high	<ol style="list-style-type: none"> 1. Cool down the Battery to room temperature 2. Reboot the system 3. Exchange Battery
ERR 4475 BATT HOT		
ERR 4476 BATT GEN	Battery hardware failure	<ol style="list-style-type: none"> 1. Reboot the system 2. Exchange Battery
ERR 447B BATT HW		
ERR 447C BATT HW		
ERR 447F BATT GEN		
ERR 4483 BATT GEN		
ERR 4484 BATT GEN		
ERR 4485 BATT GEN	Battery Software does not fit the Range Extender	<ol style="list-style-type: none"> 1. Try without Range Extender 2. Reboot the system 3. Exchange Range Extender
ERR 4486 BATT GEN	Battery hardware failure	<ol style="list-style-type: none"> 1. Reboot the system 2. Exchange Battery
ERR 4487 BATT HW	Software status of Battery or Range Extender not up to date	<ol style="list-style-type: none"> 1. Please perform software update (at least version 1.99.5 for Battery and Range Extender) 2. Exchange Battery
ERR 448A BATT HW	Battery hardware failure	<ol style="list-style-type: none"> 1. Reboot the system 2. Exchange Battery
ERR 448B BATT HW		
ERR 448E BATT GEN		
ERR 448F BATT HW		
ERR 4490 BATT HW		
ERR 4491 BATT HOT	Battery cell temperature too high	<ol style="list-style-type: none"> 1. Cool down the Battery to room temperature 2. Reboot the system 3. Exchange Battery
ERR 4492 BATT OV	Battery cell voltage too high	<ol style="list-style-type: none"> 1. Reboot the system 2. Exchange Battery
ERR 4494 BATT HOT	Battery temperature difference too high	<ol style="list-style-type: none"> 1. Cool down the Battery to room temperature 2. Reboot the system 3. Exchange Battery
ERR 4495 BATT HW	Battery hardware failure	<ol style="list-style-type: none"> 1. Reboot the system 2. Exchange Battery
ERR 4496 BATT HW		
ERR 449A BATT GEN		
ERR 449B BATT GEN		
ERR 5001 REX HW	Range Extender hardware failure	<ol style="list-style-type: none"> 1. Reboot the system 2. Range Extender plug correctly inserted, check for cable break and contamination 3. Replace wiring harness 4. Exchange Range Extender
ERR 5003 REX HW		
ERR 5004 REX SW	Range Extender – CAN initialization not possible	<ol style="list-style-type: none"> 1. Reboot the system 2. Exchange Range Extender
ERR 5005 REX HW	Range Extender hardware failure	
ERR 5007 REX OV	Range Extender cell voltage too high	
ERR 5008 REX OV		
ERR 5009 REX HW	Range Extender deep discharged or cell defect	Charge Range Extender immediately Exchange Range Extender

Error code	Cause	Remedy
ERR 500A BATT UV	Voltage of the Range Extender too low	Charge Range Extender immediately Exchange Range Extender
ERR 500C REX OV	Range Extender voltage too high	1. Reboot the system 2. Exchange Range Extender
ERR 500E REX GEN	Range Extender short circuit	
ERR 500F REX UV	Range Extender voltage too less	1. Charge Range Extender immediately 2. Exchange Range Extender
ERR 5010 REX HW	Range Extender cell difference too high	1. Reboot the system 2. Exchange Range Extender
ERR 5011 REX UV	Range Extender voltage too less	1. Charge Range Extender immediately 2. Exchange Range Extender
ERR 5012 REX OV	Range Extender voltage too high	1. Reboot the system 2. Exchange Range Extender
ERR 5014 BATT HW	Cell difference measurement of the Range Extender too high	1. Reboot the system 2. Please perform software update (at least version 1.99.5) 3. Exchange Range Extender
ERR 5015 REX UV	Range Extender voltage too less	1. Reboot the system 2. Exchange Range Extender
ERR 5016 REX HW	Range Extender charging not possible	
ERR 5017 REX HW	Range Extender cell voltage too less	
ERR 5018 REX HW	Range Extender hardware failure	
ERR 5019 REX HW		
ERR 501B REX HW	Range Extender cell temperature deviation	1. Cool down or warm up the Range Extender to room temperature 2. Reboot the system 3. Exchange Range Extender
ERR 501C REX HOT	Range Extender cell temperature too high	1. Cool down the Range Extender to room temperature 2. Reboot the system 3. Exchange Range Extender
ERR 501D REX COLD	Range Extender cell temperature too low	1. Warm up the Range Extender to room temperature 2. Reboot the system 3. Exchange Range Extender
ERR 501E REX HOT	Range Extender cell temperature too high	1. Cool down the Range Extender to room temperature 2. Reboot the system 3. Exchange Range Extender
ERR 501F REX COLD	Range Extender cell temperature too low	1. Warm up the Range Extender to room temperature 2. Reboot the system 3. Exchange Range Extender
ERR 5020 REX HOT	Range Extender cell temperature too high	1. Cool down the Range Extender to room temperature 2. Reboot the system 3. Exchange Range Extender
ERR 5021 REX HOT		
ERR 5022 REX COLD	Range Extender cell temperature too low	1. Warm up the Range Extender to room temperature 2. Reboot the system 3. Exchange Range Extender
ERR 5023 REX COLD		
ERR 5024 REX HW	Range Extender hardware failure	1. Reboot the system 2. Exchange Range Extender
ERR 5028 REX HW		
ERR 5029 REX HW		
ERR 502A REX HW		
ERR 502B REX HW		
ERR 502C REX HW		



Error code	Cause	Remedy		
ERR 502D BATT HW	Range Extender hardware error	<ol style="list-style-type: none"> 1. Reboot the system 2. Range Extender plug correctly inserted, check for cable break and contamination 3. Replace wiring harness 4. Exchange Range Extender 		
ERR 502F REX HOT	Range Extender temperature too high	<ol style="list-style-type: none"> 1. Cool down the Range Extender to room temperature 2. Reboot the system 3. Exchange Range Extender 		
ERR 5030 REX HW	Range Extender hardware failure	<ol style="list-style-type: none"> 1. Reboot the system 2. Exchange Range Extender 		
ERR 5031 REX HW				
ERR 5032 REX HW				
ERR 5033 REX HW				
ERR 5034 REX HW				
ERR 5035 REX HW				
ERR 5036 BATT HW	Range Extender hardware error	<ol style="list-style-type: none"> 1. Reboot the system 2. Range Extender plug correctly inserted, check for cable break and contamination 3. Replace wiring harness 4. Exchange Range Extender 		
ERR 5037 REX HW	Range Extender hardware failure	<ol style="list-style-type: none"> 1. Reboot the system 2. Exchange Range Extender 		
ERR 5039 REX HW				
ERR 503A REX GEN	Range Extender charge overcurrent			
ERR 503B REX GEN	Range Extender discharge overcurrent			
ERR 503D REX HW	Range Extender hardware failure			
ERR 503E REX GEN	Range Extender overcurrent			
ERR 503F REX HW	Range Extender hardware failure	<ol style="list-style-type: none"> 1. Reboot the system 2. Exchange Range Extender 		
ERR 5041 REX HW				
ERR 5042 REX HW				
ERR 5043 REX HW				
ERR 5044 REX HW				
ERR 5046 REX HW				
ERR 5047 REX HW				
ERR 5048 REX HW				
ERR 5049 REX SW				
ERR 504B REX HW				
ERR 5050 REX OV			Range Extender cell voltage too high	<ol style="list-style-type: none"> 1. Reboot the system 2. Exchange Range Extender
ERR 5055 REX HW			Range Extender hardware failure	
ERR 5062 REX HW				
ERR 5063 REX HW				
ERR 5064 BATT HW	Reference voltage of the Range Extender too high			
ERR 506C REX HW	Range Extender hardware failure			
ERR 506E REX HW				
ERR 5071 REX HW				
ERR 5072 REX HW				
ERR 5073 REX HW				



Error code	Cause	Remedy
ERR 5074 REX HOT ERR 5075 REX HOT	Range Extender hardware failure	<ol style="list-style-type: none"> 1. Cool down the Range Extender to room temperature 2. Reboot the system 3. Exchange Range Extender
ERR 5076 REX GEN ERR 507B REX HW ERR 507C REX HW ERR 507F REX GEN ERR 5083 REX GEN ERR 5084 REX GEN	Range Extender hardware failure	<ol style="list-style-type: none"> 1. Reboot the system 2. Exchange Range Extender
ERR 5085 REX GEN	Range Extender Software does not fit the Battery	<ol style="list-style-type: none"> 1. Try without Range Extender 2. Reboot the system 3. Exchange Range Extender
ERR 5086 REX GEN	Range Extender hardware failure	<ol style="list-style-type: none"> 1. Reboot the system 2. Exchange Range Extender
ERR 5087 REX HW	Software status of Battery or Range Extender not up to date	<ol style="list-style-type: none"> 1. Please perform software update (at least version 1.99.5 for Battery and Range Extender) 2. Exchange Range Extender
ERR 508A REX HW ERR 508B REX HW ERR 508E REX GEN ERR 508F REX HW ERR 5090 REX HW	Range Extender hardware failure	<ol style="list-style-type: none"> 1. Reboot the system 2. Exchange Range Extender
ERR 5091 REX HOT	Range Extender cell temperature too high	<ol style="list-style-type: none"> 1. Cool down the Range Extender to room temperature 2. Reboot the system 3. Exchange Range Extender
ERR 5092 REX OV	Range Extender cell voltage too high	<ol style="list-style-type: none"> 1. Reboot the system 2. Exchange Range Extender
ERR 5094 REX HOT	Range Extender temperature difference too high	<ol style="list-style-type: none"> 1. Cool down the Range Extender to room temperature 2. Reboot the system 3. Exchange Range Extender
ERR 5095 REX HW ERR 5096 REX HW ERR 509A REX GEN ERR 509B REX GEN	Range Extender hardware failure	<ol style="list-style-type: none"> 1. Reboot the system 2. Exchange Range Extender
ERR 5401 DRV CONN	Communication error between drive unit and display	<p>Connection problem between motor and display. Update not performed properly. Electronics fault in display and/or motor.</p> <ol style="list-style-type: none"> 1. Reboot the system 2. In case of outdated firmware or if an update was not properly carried out, please perform a software update 3. Check peripheral components for wire breaks, along with cable and plug connections 4. Replace display 5. Replace motor
ERR 5402 REM BTN ERR 5403 REM BTN	Remote button pressed when switching on	<ol style="list-style-type: none"> 1. Do not hold down remote button during startup 2. Check jammed keys for dirt and clean if necessary 3. Replace remote 4. Replace display
WRN 5404 REM BTN	Walk assist user error	<p>Instruct users in the proper use of walk assist!</p> <ol style="list-style-type: none"> 1. Activate walk assist by pressing the up key (Walk) of the remote until Walk appears on the display 2. Then immediately release the button and press it again to use walk assist



We have checked the contents of the publication for conformity with the product described. Nevertheless, deviations cannot be excluded, so that we do not assume any liability for complete conformity and correctness.

The information in this publication is reviewed periodically and necessary corrections are included in subsequent editions.

All trademarks mentioned in this manual are the property of their respective owners.

Copyright © TQ-Systems GmbH